

INSTRUCTION DE MONTAGE / INSTRUCTION NOTICE

Etagère 3 niveaux blanc / tall shelf

Reference : 334930

(Conservez ces informations pour vous y référer ultérieurement / Information to be kept)

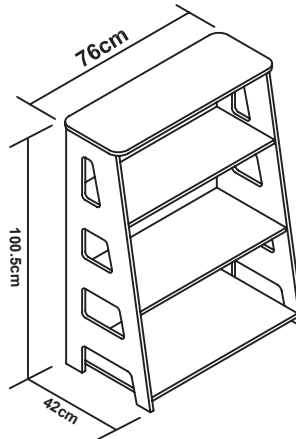
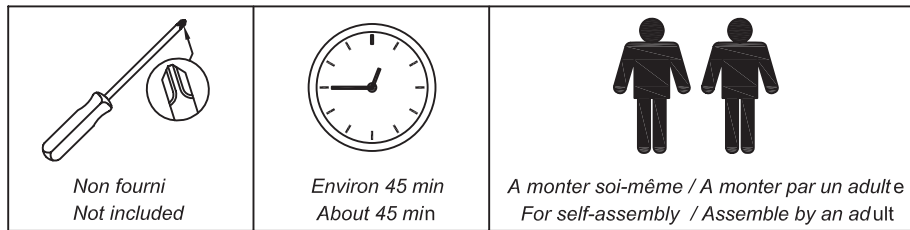

*Les détails et caractéristiques du produit peuvent varier par rapport à la photo
Contents and features may vary from illustration shown.*

INFORMATIONS IMPORTANTES POUR L'UTILISATION ET LA SECURITE

Pour un montage en toute sécurité :

- Réaliser le montage dans une zone dégagée, loin de tout obstacle.
- Respecter les instructions fournies.
- Tenir hors de portée des enfants les éléments constituant le produit et les éléments d'emballage.

Pour une utilisation en toute sécurité :

- Ne pas placer le produit près d'une fenêtre.
- Monter et utiliser ce produit sur une surface plane.
- A poser au sol et à fixer au mur pour éviter tout basculement du meuble.
- Vérifier régulièrement le bon état des différents matériaux et l'assemblage du produit (serrage des vis).
- Ne pas placer le produit près d'une source de chaleur, comme les appareils de chauffage électrique ou à gaz.

Toutes négligences pourraient être source d'accidents.

Entretien :

- Nettoyer régulièrement le produit avec un chiffon doux.

Pour des raisons d'hygiène, nous vous recommandons d'aérer quotidiennement la chambre de votre enfant.

Un ballon plastique en contact avec ce meuble pourrait endommager sa peinture. Si vous souhaitez y stocker des ballons, il est impératif de les emballer au préalable.

Warning!

Build and use on household floors.

To be fixed to the wall

Please read and follow all instructions in this notice.

Please keep all screws, small parts and plastic bags out of reach of small children. The K/D products contain small parts and sharp edges that are not suitable for children to access. Care should be taken in unpacking and assembling the product.

For security reasons:

- *Keep this item away from windows.*
- *Keep this item away from heat.*
- *Regularly check and tighten loose fittings.*







For hygiene reasons, we recommend you to ventilate rooms in all housing daily.

A plastic ball in contact with this furniture could damage its paint. If you want to store balls in it, it is essential to wrap them up beforehand.

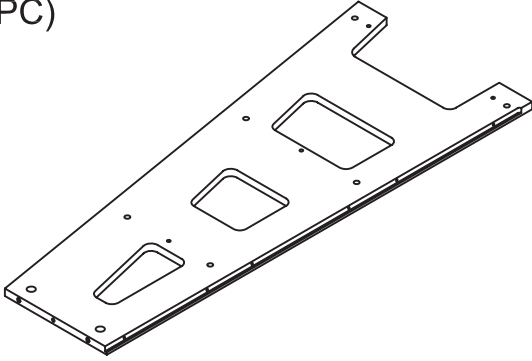
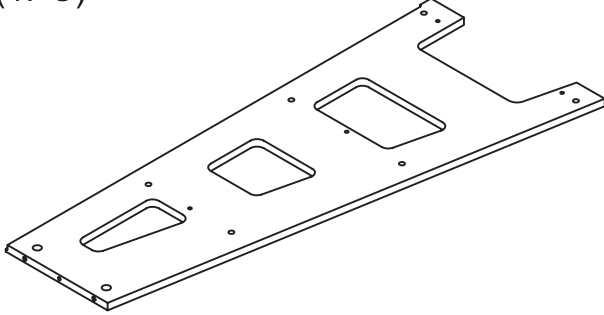
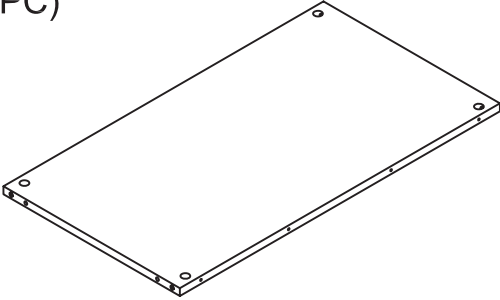
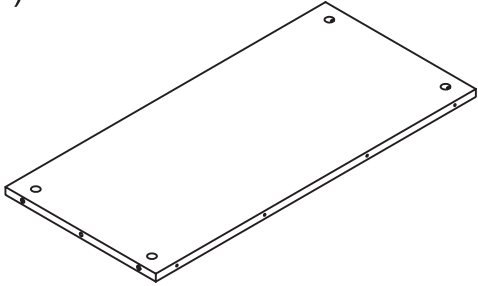
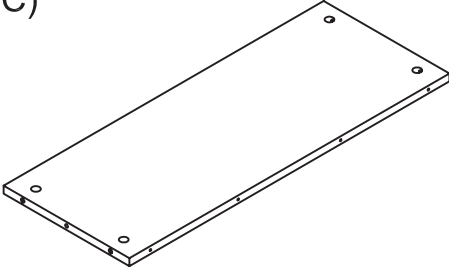
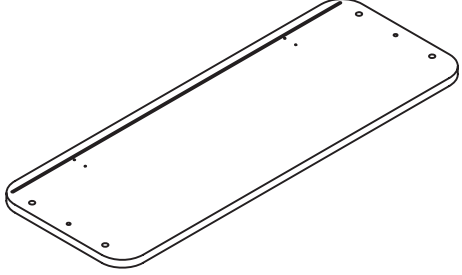
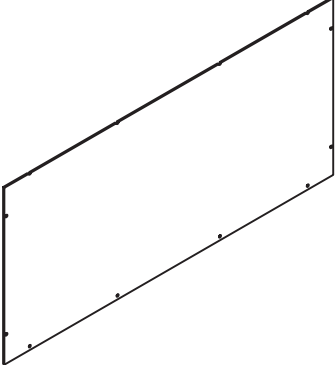
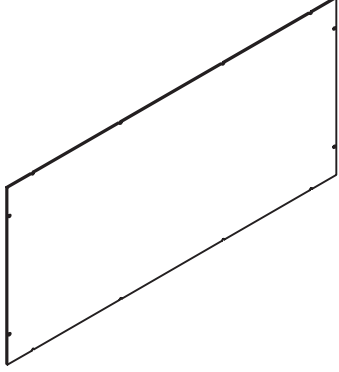
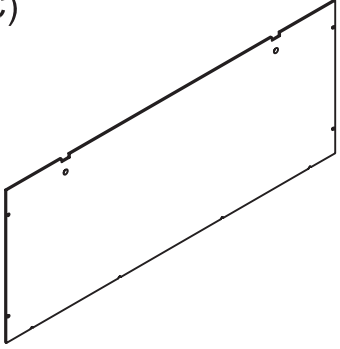
Oxybul Eveil & Jeux
162 Boulevard de Fourmies
59100 Roubaix
France

Fabriqué en Chine / Made in China

Eléments et pièces détachées / Parts and screws

<p>A(1PC)</p> 	<p>B(1PC)</p> 				
<p>C(1PC)</p> 	<p>D(1PC)</p> 				
<p>E(1PC)</p> 	<p>F(1PC)</p> 				
<p>G(1PC)</p> 	<p>H(1PC)</p> 				
<p>I(1PC)</p> 	<p>J(16PCS)</p> 	<p>K(16PCS)</p> 	<p>L(24PCS)</p> 		
<p>M(10PCS)</p> 				<p>N(4PCS)</p> 	<p>O(2PCS)</p> 

1

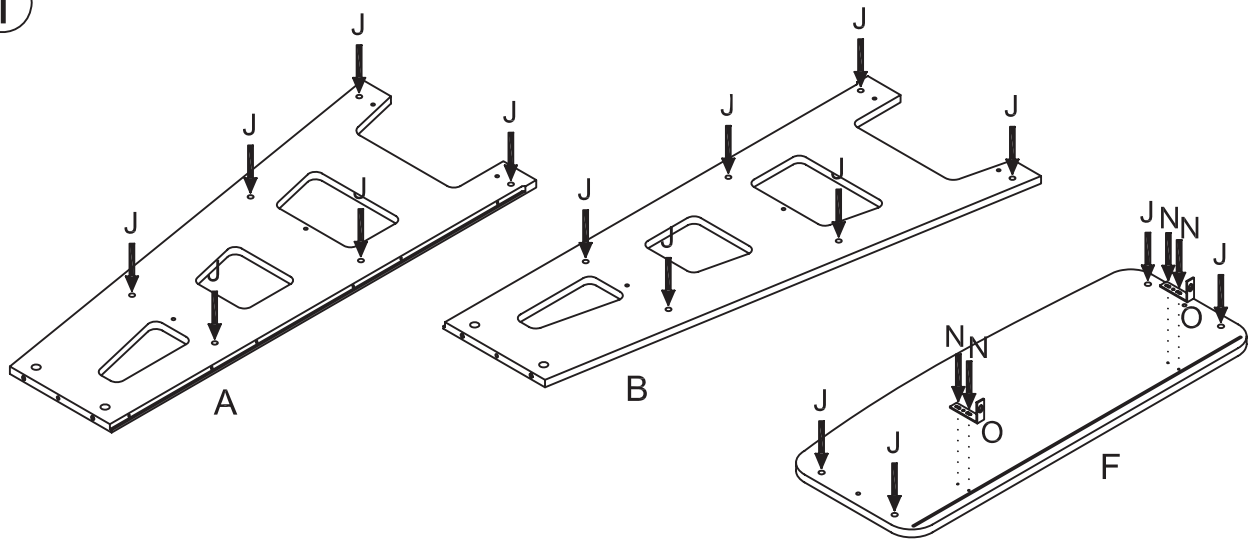

2

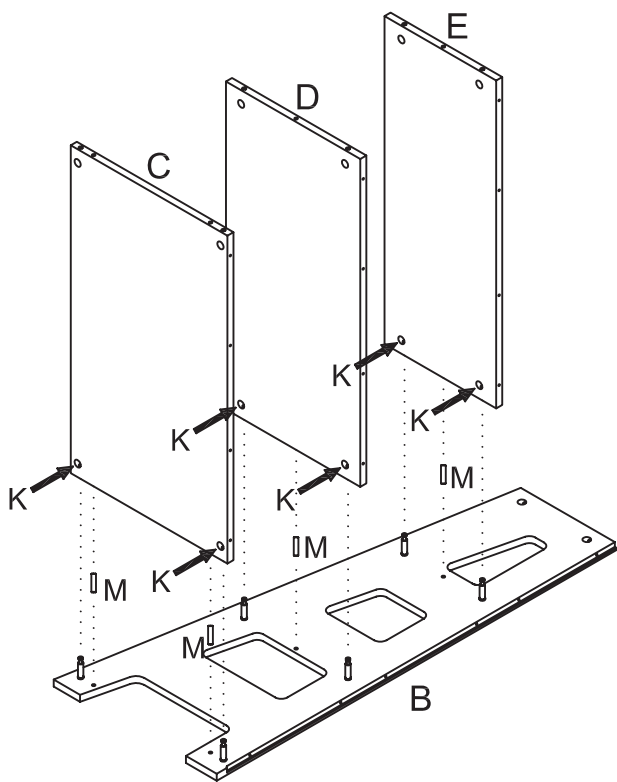

3

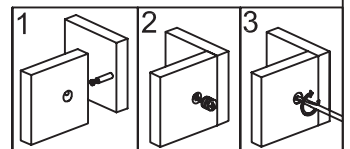
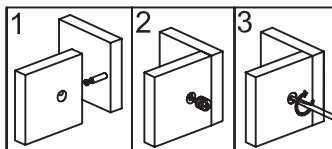
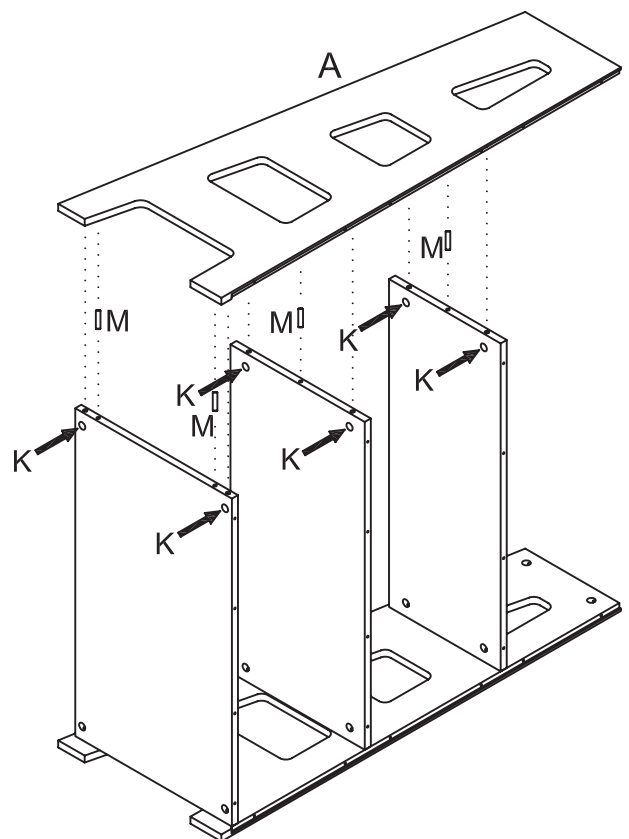

4

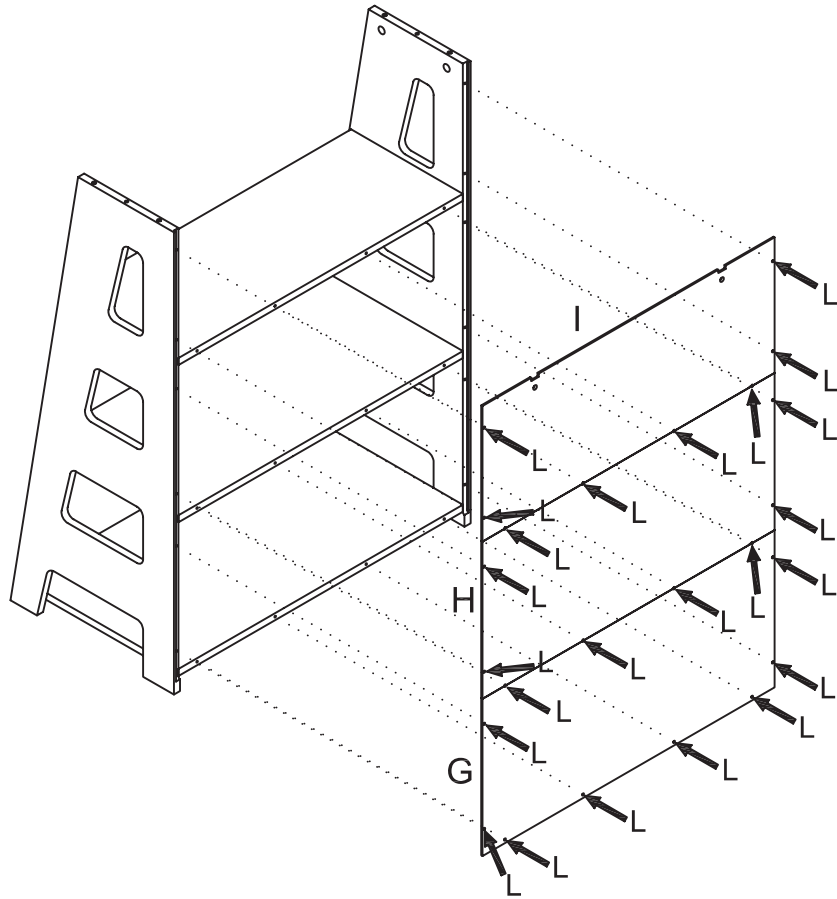

5

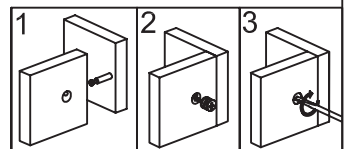
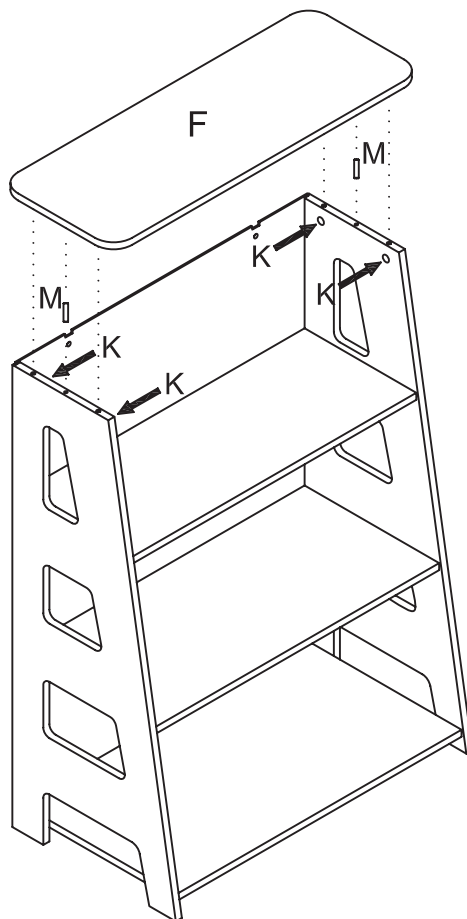

6

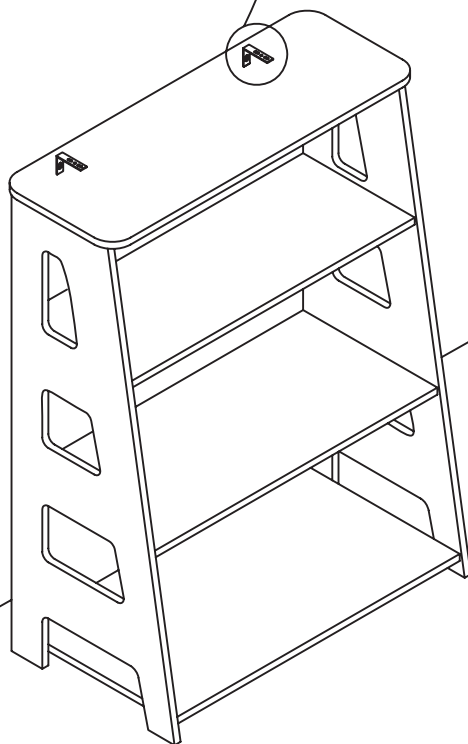
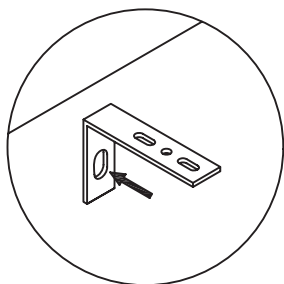



Il existe une grande diversité de types de murs ou cloisons. C'est la raison pour laquelle nous ne pouvons vous fournir le type exact de fixation. Il est nécessaire d'identifier le type de paroi à laquelle vous allez fixer ce produit afin de vous procurer les fixations appropriées. Voici quelques exemples de fixation recommandées pour:



LES MURS PLEINS

CHEVILLE NYLON
"FISCHER"

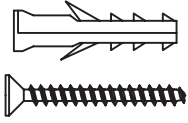

CHEVILLE D'ANCRAGE
MÉTAL

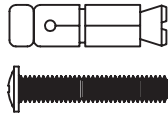

CHEVILLE D'ANCRAGE
A AILETTES EN NYLON

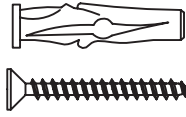

CHEVILLE D'ANCRAGE
A AILETTES EN NYLON

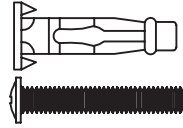

CHEVILLE "MOLLY"

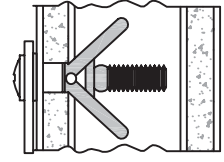
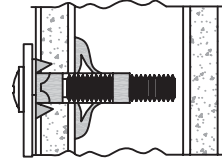
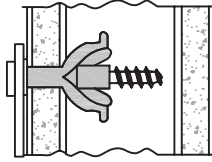
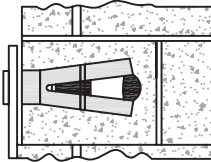
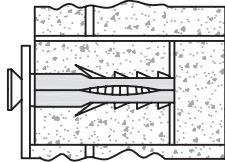
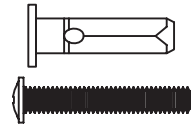

Utiliser une taille de foret adaptée à la quincaillerie utilisée et au type de mur



Due to the wide diversity of wall or partition types, we cannot provide you with suitable attachment fixtures. To determine which attachment fixtures is required, you will need to identify the type of wall to which you will be fixing this product. Here are some examples of attachment fixtures recommended for:



BLIND WALLS

"FISCHER"
Nylon plug

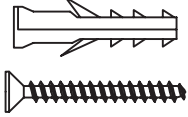

Metal
Wall plug

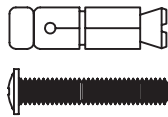

Nylon winged
Wall plug

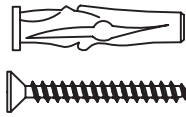

STUDDED WALLS

Metal expansion
plug

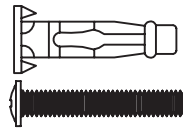

"MOLLY" plug

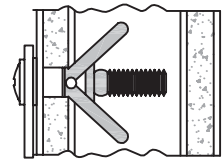
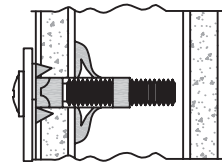
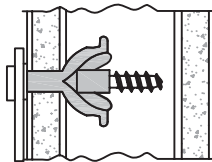
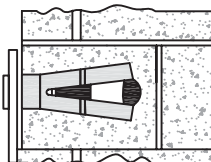
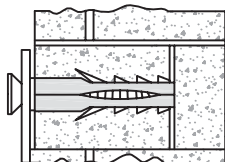
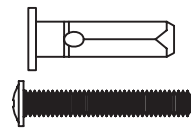

Use a drill bit that is compatible in size with the hardware used and the type of wall